

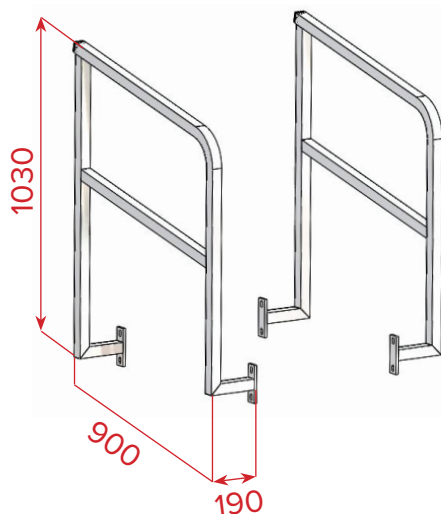

Garde-corps en acier 40x40mm.

Pour tribune 3 rangs

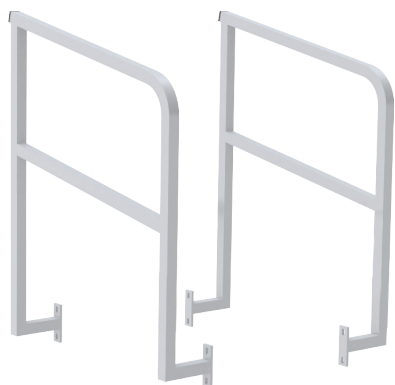

Hauteur	1.03m
Largeur	0.90m
Profondeur	0.19m
Forme du profil	Carré
Dimensions du profil	40x40mm
Poids/unité	26 kg
Matériau	Acier
Couleur	Plastifié blanc

AVANTAGES

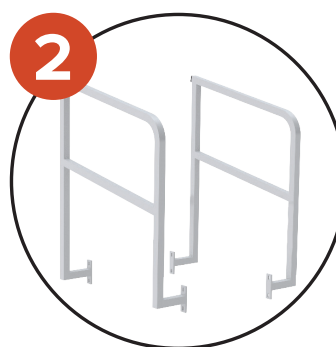
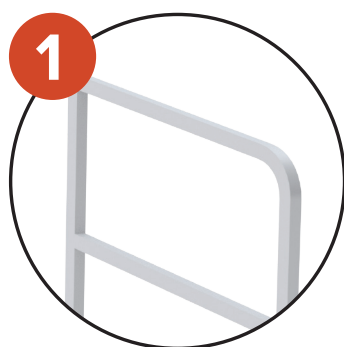

1. Les bords sont arrondis pour éviter de se blesser

2. La structure en acier 40x40mm et une barre de renfort horizontale assurent une rigidité optimale

PRODUITS ASSOCIÉS

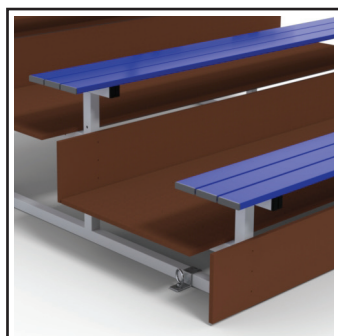

Option contre-marches



S35530 - Tribunes emboîtables 3 rangs. Avec 4 tribunes, 1 escalier et 2 garde-corps

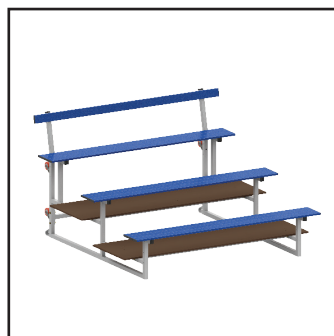

S35630 - Tribune mobile 3 rangs. STANDARD

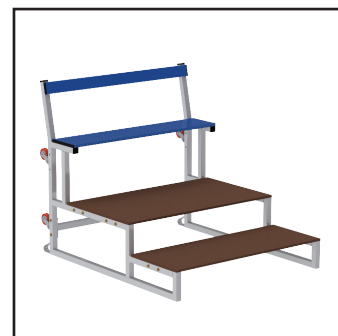

S35631 - Escalier pour tribune 3 rangs

