









Liste des composants:

No.	Image	Quantité
A		1PC
B		1PC
C		1PC
D		3PCS
E		6PCS
F		3PCS
G		3PCS
H		9PCS
I		1PC

NOTICE DE MONTAGE

Table haute break

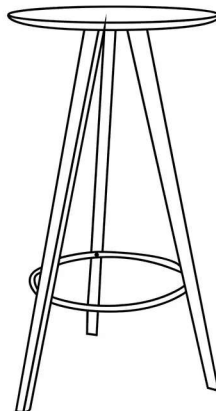

1<sup>ème</sup> étape

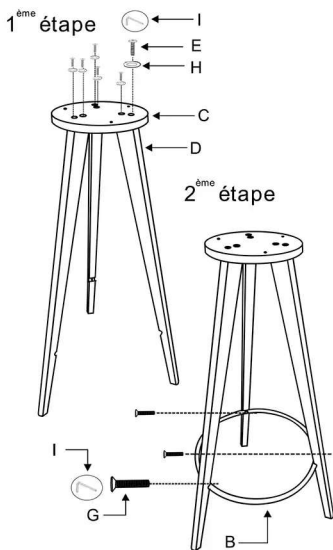

2<sup>ème</sup> étape

3<sup>ème</sup> étape

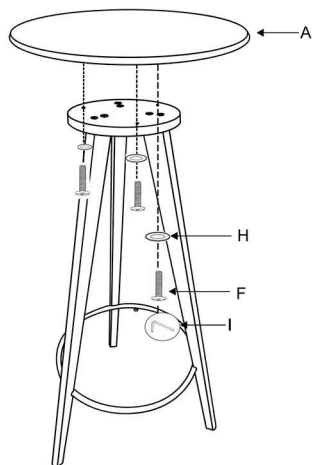

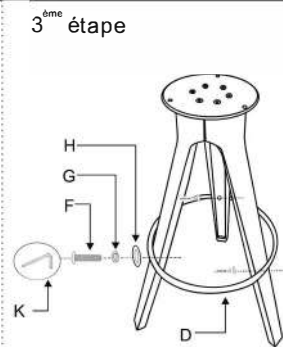
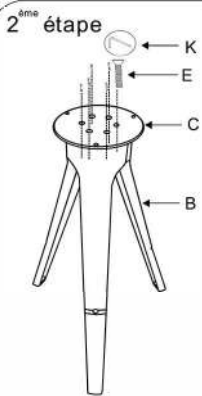

Liste des composants:

No.	Image	Quantité
A		1PC
B		3PCS
C		1PC
D		1PC
E		6PCS
F		3PCS
G		3PCS
H		3PCS
I		3PCS
J		3PCS
K		1PC

NOTICE DE MONTAGE  
Tabouret Break

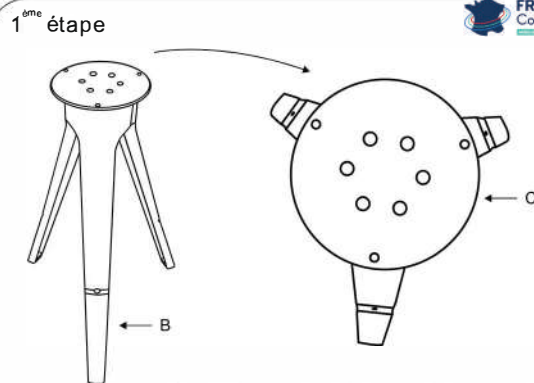
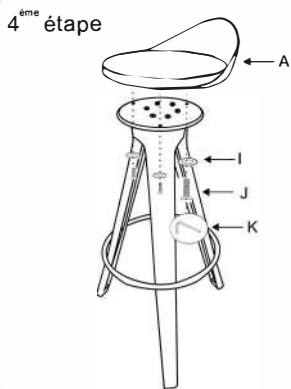
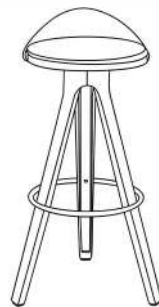

Les 3 préperçages de la pièce "C" doivent être alignés avec les pieds.